

INSTRUCTIONS FOR USE
INTENDED USE

The Merit ASAP Aspiration Catheter is intended for the removal of fresh, soft emboli and thrombi from vessels of the arterial system.

CAUTIONS

RX Only: Caution: Federal Law (USA) restricts this device to sale by or on the order of a physician.

Read instructions prior to use.

Store in a cool, dry place.

Inspect contents prior to use.

Do not expose to organic solvents such as alcohol.

Product is intended for single use only.

Do not reuse or re-sterilize; do not autoclave.

Do not use if package is opened or damaged.

The ASAP Aspiration Catheter should be used by physicians with adequate training in the use of the device.

Kit components should not be substituted.

Contents of unopened, undamaged package are sterile and non-pyrogenic.

Crossing a freshly deployed drug eluting stent could damage the delicate drug coating.

WARNINGS

Do not use a bent, kinked or damaged catheter as this may lead to vessel injury and/or an inability to advance or withdraw the catheter.

Do not advance the guide wire if resistance is met.

Do not place more than 60mls of fluid in the MicroStop™ fluid collection basin.

The ASAP Aspiration catheter must be used with a guide catheter with a minimum internal diameter of 0.070"/1.78mm.

Do NOT flush the system while the catheter is still inside the patient vasculature.

POTENTIAL COMPLICATIONS

Potential complications include, but are not limited to:

Local or systemic infection; local hematomas; intimal disruption; arterial dissection; perforation and vessel rupture; arterial thrombosis; distal embolization of blood clots and plaque; arterial spasm; arteriovenous fistula formation; catheter fracture with tip separation and distal embolization; acute myocardial infarction; emergent surgery; death; abrupt closure of total occlusion of treated graft or vessel; distal embolization of debris resulting in pulmonary compromise and/or limb ischemia; death, myocardial infarction; coronary or bypass graft thrombosis or occlusion, myocardial ischemia; stroke/CVA; emergent or non-emergent fibrillation; hemorrhage; hypotension; pseudo aneurysm at access site.

Risks normally associated with percutaneous diagnostic and/or interventional procedures.

CONTRAINDICATIONS

Do not use in vessels less than 2.0mm in diameter.

The venous system.

The removal of fibrous, adherent or calcified material (i.e. chronic clot, atherosclerotic plaque)

Not for use in the cerebral vasculature.

ADDITIONAL EQUIPMENT REQUIRED BUT NOT SUPPLIED

Guiding catheter with an internal diameter of at least 0.070"/1.78mm

Guide wire with diameter of $\leq 0.014"/0.36\text{mm}$

Rotating hemostasis valve

Sterile, heparinized normal saline for system flushing

PRODUCT DESCRIPTION

The ASAP Aspiration Catheter Kit contains a dual lumen rapid exchange catheter, compatible with 0.014"/0.36mm guide wires with related accessories. The catheter has a maximum outer diameter of 0.068"/1.73mm and a working length of 140cm. The catheter is placed through a 6F guide catheter with a minimum inner diameter of 0.070"/1.78mm. The catheter has a radiopaque marker band located approximately 2mm proximal to the distal tip. The catheter has three (3) non-radiopaque positioning marks located approximately 90cm, 100cm, and 110cm proximal to the distal tip. Catheter has a distal hydrophilic coated section of 20cm.

The kit consists of the following components. These components may be packaged together or separately.

- (1) ASAP Aspiration Catheter
- (2) 30ml VacLok® syringes
- (2) 70 micron pore filter baskets
- (1) MicroStop fluid collection basin with lid
- (1) Extension tubing set (8 1/2"/21.5cm total length) with one-way stopcock
- (1) RXP® flush syringe (4ml)

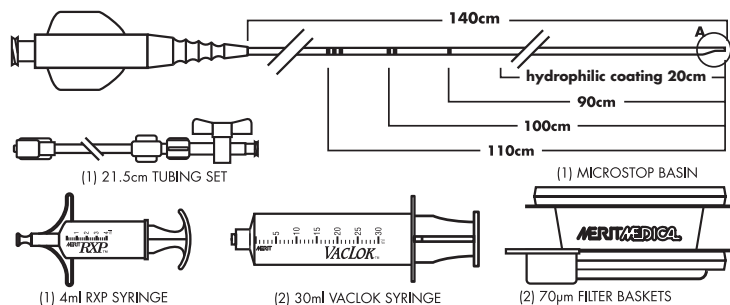

INSTRUCTIONS FOR USE

The following instructions provide technical direction but do not obviate the necessity of formal training in the use of extraction or aspiration catheters. The techniques and procedures described do not represent all medically acceptable protocols, nor are they intended as a substitute for the physician's experience and judgment in treating any specific patient.

Preparation and Directions for Use:

1. Open the ASAP Aspiration Kit box. Using aseptic technique, open the pouch and transfer the tray onto the sterile field.
2. Remove the catheter hoop containing the ASAP catheter and other kit components from the tray. Attach a 10ml syringe, (or one of the 30ml VacLok syringes included in kit), filled with heparinized saline to the flush port on catheter hoop; flush hoop completely to activate hydrophilic coating on distal portion of catheter.
3. Inspect the catheter for any bends or kinks. Remove the wire stylet from the rapid exchange lumen.
4. Use 4ml RXP syringe filled with heparinized saline to flush rapid exchange lumen.
5. Flush extension tubing set with heparinized saline prior to use. Using one of the VacLok syringes, draw 5-10ml of heparinized saline into the syringe. Attach the extension tubing set with stopcock to the catheter. Turn the stopcock to the "open" position and flush with the heparinized saline solution to remove all air from the system.
6. Turn the stopcock to the "off/closed" position after the catheter system is properly flushed. Verify that the stopcock on the extension tubing set is in the closed position and connect the VacLok syringe to the tubing set. Check that all fittings are secure so that air is not introduced into the extension line during aspiration/extraction.
7. VacLok syringe setup: To create and maintain vacuum, withdraw the VacLok syringe plunger to the desired position and rotate the plunger clockwise to position one of the locking fins behind the stop pin. Turn the plunger counterclockwise to release. (see fig. A)
8. Check that all fittings are secure so that air is not introduced into the extension line or syringe during aspiration. At this time verify that the extension tubing set with stopcock is on the catheter (stopcock in the "closed" position) with VacLok syringe attached. The ASAP catheter is completely prepped and is ready for use.

Figure A

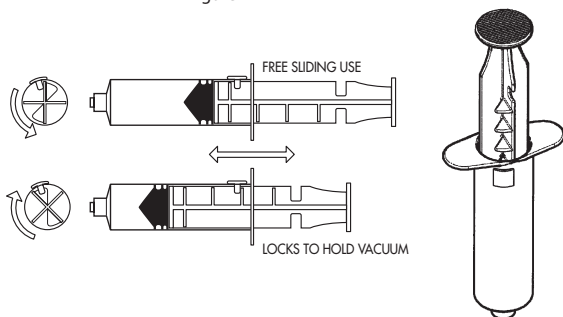

USE OF THE ASAP CATHETER DURING AN INTERVENTIONAL PROCEDURE

Perform aspiration using the ASAP Catheter:















9. Load the prepped ASAP Catheter over the $\leq 0.014"/0.36\text{mm}$ guide wire.
10. Confirm that the tubing set/VacLok have been connected to the catheter prior to placement through guide catheter.
11. Advance the ASAP Catheter through the guide catheter, under fluoroscopy, and continue to advance the catheter over the guidewire to the selected vascular site. The ASAP catheter has three non-radiopaque positioning marks indicating 90cm, 100cm & 110cm from the catheter tip. Position the distal tip marker proximal to the desired site. Stop advancement of the ASAP Catheter if any resistance is encountered.

WARNING: Never advance or withdraw an intravascular device against resistance until the cause of the resistance is determined by fluoroscopy. Movement of the catheter or guide wire against resistance may result in damage to the catheter, or vessel perforation.

12. After fluoroscopically confirming catheter position, open the stopcock to begin aspiration.
Advance the catheter slowly distally away from the guiding catheter. Blood will enter the VacLok Aspiration Syringe until the entire vacuum is gone (or the VacLok Aspiration Syringe is filled).
 - a. If the syringe does not begin to fill with blood within 5 seconds, close stopcock and remove ASAP catheter. Flush the catheter (extraction lumen) or use a new catheter. Repeat steps 9-11. **Warning** – Do not flush the system while the catheter is still inside the patient vasculature.
 - b. After completing the aspiration process, turn the stopcock to the "Off" position and remove the catheter, or attach a second syringe and repeat aspiration.
 - c. Blood and thrombus aspirated into the syringe may be filtered for subsequent laboratory analysis.
13. Remove the ASAP Catheter: if necessary, loosen the rotating hemostasis valve to allow easy withdrawal of the catheter.

USE OF THE MICROSTOP BASIN AND FILTER BASKETS

- a. Wet the mesh of the filter basket to allow fluid flow.
- b. Place filter basket in MicroStop fluid collection basin.
- c. Carefully dispense extracted blood into filter basket (blood will go through filter basket and collect in MicroStop) and filter the extracted blood through the filter basket.
Any fresh, soft emboli and/or thrombi (larger than 70 micron) that have been aspirated should remain in the filter basket.
- d. If necessary, use the second filter basket included in the kit to continue filtering blood.
- e. Locate the lid for the MicroStop Waste Basin (sitting underneath the MicroStop Basin in the kit tray).
- f. Place the lid on MicroStop Waste Basin until lid snaps into place.
- g. Dispose of closed waste basin according to designated guidelines for the disposal of contaminated human waste.

SYMBOL	DESIGNATION
	Catalog Number
	Lot Number
	Caution: Consult accompanying documentation
	For electronic copy scan QR Code, or go to www.merit.com/ifu and enter IFU ID Number. For printed copy, call Customer Service.
	Sterilized using Ethylene Oxide
	Do not use if package is damaged.
	Single Use
	Use By
	Do Not Resterilize
	Non-pyrogenic
	Keep away from sunlight
	Single sterile barrier system with protective packaging inside
	Manufacturer
	Medical Device
	Date of Manufacture
	6F Guide Catheter Compatible
	5.2F Catheter



www.merit.com



Manufacturer:
 Merit Medical Systems, Inc.
 1600 West Merit Parkway, South Jordan, Utah 84095 U.S.A.
 1-801-253-1600 U.S.A. Customer Service 1-800-356-3748